

# TAMRON

## SP AF 17~50 mm F/2.8 XR Di-II LD Aspherical [IF] (Model A16)



Thank you for purchasing the Tamron lens as the latest addition to your photographic equipment. Di II lens (Digitally Integrated) series are designed for digital SLR cameras with image sensors equivalent to APS-C size. Before using your new lens, please read the contents of this Owner's Manual thoroughly to familiarize yourself with your lens and the proper techniques for creating the highest quality images possible. With proper handling and care, your Tamron lens will give you many years of photographing beautiful and exciting pictures.

1

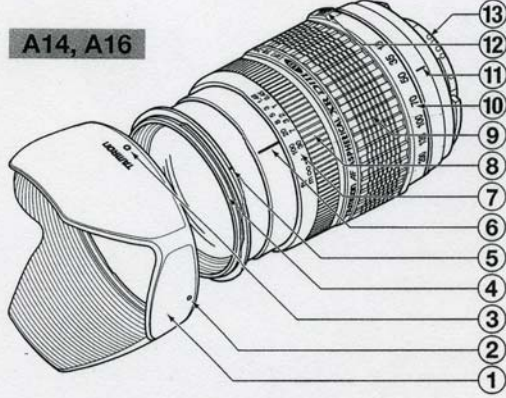
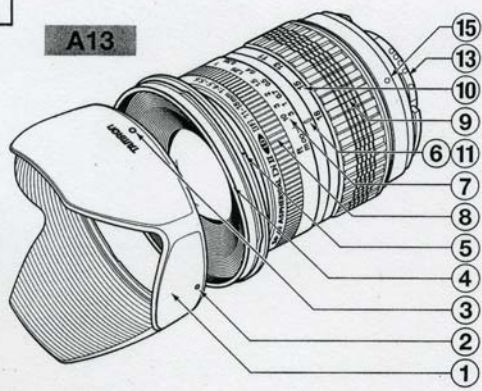

2

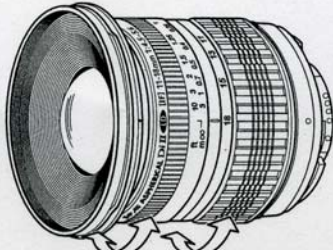

A13

Focusing Zooming

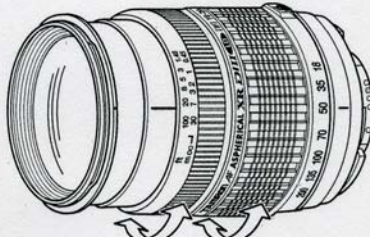

A14, A16

Focusing Zooming

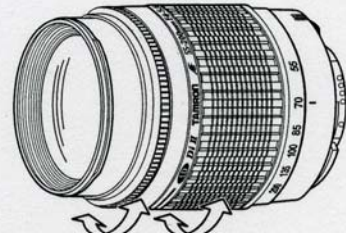

A15

Focusing Zooming

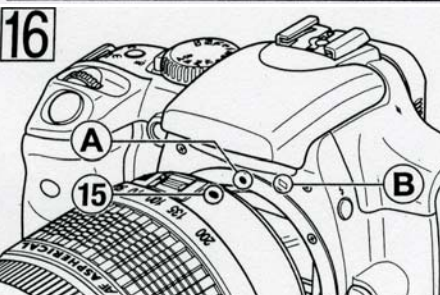
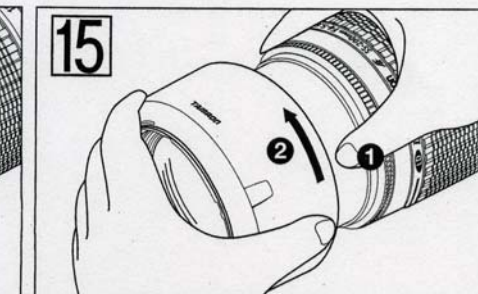
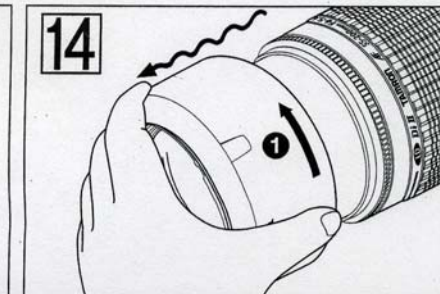
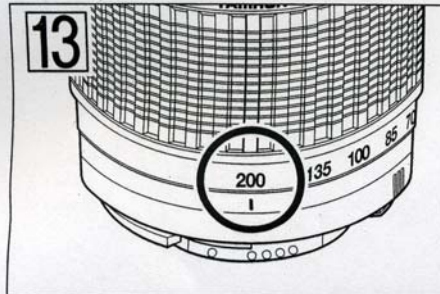
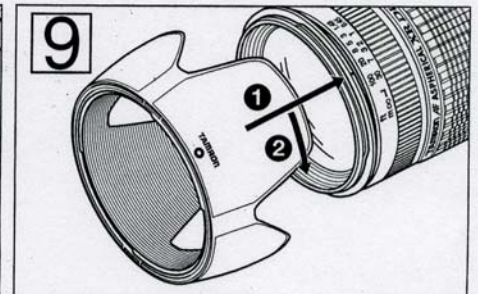
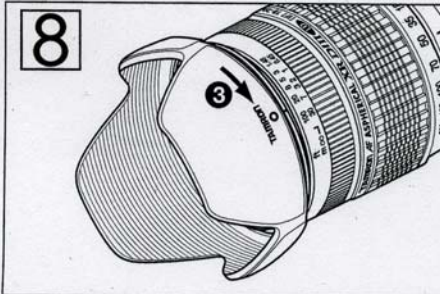
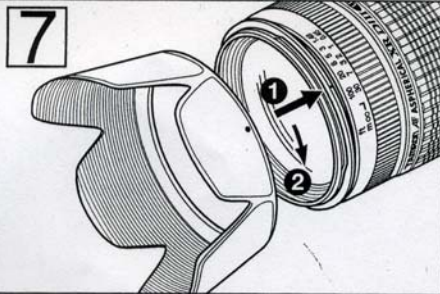
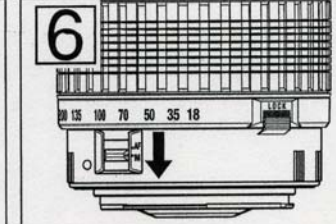
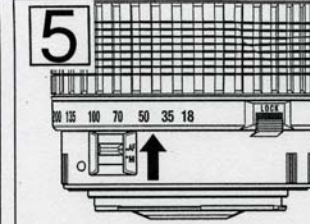
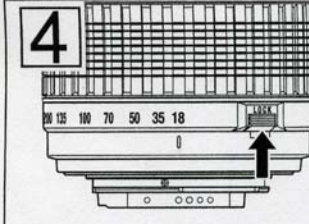
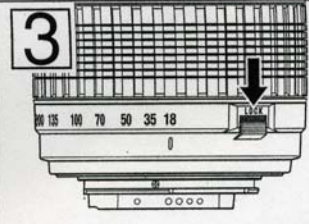

## NOMENCLATURE

1. Lens Hood
2. Hood attaching alignment mark
3. Hood attaching indicator
4. Filter Ring
5. Hood attaching bayonet ring
6. Distance index
7. Distance scale
8. Focusing ring
9. Zooming ring
10. Focal length scale
11. Zoom index mark
12. Zoom lock switch (A16) Figs 3 & 4
13. Lens mount/Lens mount contacts (Nikon)
14. AF-MF altering switch (Canon Fig 5 & 6)
15. Lens attachment mark
16. Bayonet tab on the hood
17. Bayonet tab on the lens

## SPECIFICATIONS

	<b>A16</b>
Focal Length	17-50mm
Maximum Aperture	F/2.8
Angle of View	78°45'-31°11'
Lens Construction	13/16
Minimum Focus Distance	0.27m
Filter Size	67mm
Length	83.2mm
Diameter	73.8mm
Hood	DA09

\* Lengths and weights listed in lens specifications are for lenses with Nikon mounts.

\* Features and cosmetic designs of lenses listed in this owner's manual may be revised without notice.



## ATTACHING LENS TO CAMERA

### How to mount the lens

Removing the rear cap of the lens, align the lens attachment mark on the lens barrel with its counterpart on the lens mount of the camera and insert the lens mount into the camera's mount opening. Rotate the lens clockwise until it click-locks. For Nikon models, align the lens attachment mark with the dot on the camera and rotate the lens counter-clockwise until it click-locks.

### How to detach the lens

Pressing the lens release button of the camera down, turn the lens counter-clockwise (clockwise in case on Nikon), and lift the lens off the camera's lens mount.

\* For further details, please read the instruction manual of your camera.

## FOCUSING (Autofocus) (Ref. Figs. 1 & 2)

Set the camera on the autofocus mode (AF). Press the shutter button lightly while viewing through the camera's viewfinder, the lens focuses automatically. An in-focus mark will light when lens focuses on the main subject sharply. Press the shutter button further to photograph.

\* Also, please read the camera's instruction booklet carefully.

When set on AF mode, be very careful not to hinder the autofocusing movements of the lens. Such interference may cause a serious damage on the lens mechanism.

Select between the autofocus and manual focus modes by the AF/MF mode selector switch on the lens barrel.

\* For further details, please read the instruction manual of your camera.

## FOCUSING (Manual Focus) (Ref. Fig. 2)

Switch the focusing mode switch of the camera to manual focusing mode (MF) in case of Nikon, Minolta, or Pentax camera. In case of Canon, switch to MF on the AF-MF altering switch on the lens barrel. Focus manually, rotating the focusing ring while viewing through the camera's viewfinder. The main subject image in the viewfinder will be critically sharp on the viewfinder screen as lens focuses rightly.

Press the shutter button lightly while operating the lens for focusing. The focus aid mark in the viewfinder will light up when the subject is in critical focus.

Make sure the subject at infinity appears sharp in the finder when in focus. Because, the infinity position on the lens is made with certain allowance to assure right focus under a wide variety of photographing conditions.

\* For further details, please read the instruction manual of your camera.

## ATTACHING AND REMOVING THE LENS

### How to mount the lens

Remove the rear cap of the lens. Align the lens attachment mark (15) on the lens barrel with its counterpart on the camera mount and insert the lens. Rotate the lens clockwise until it click-locks. For Nikon and Pentax models, align the lens attachment mark on the camera and the lens attachment mark (15) on the lens to attach the lens. For Nikon models, align the lens attachment mark with the dot on the camera and rotate the lens counter-clockwise until it click-locks.

### How to detach the lens

Pressing the lens release button on the camera down, turn the lens counter-clockwise (in case of Nikon lens, clockwise), and lift the lens off the camera's lens mount.

The image circles of Di-II lenses are designed to match the digital SLR cameras using the image sensors equivalent to APS-C (approx. 15.5 x 23.2mm). Do not use Di-II lenses with cameras using image sensors larger than APS-C. Using Di-II lenses with such cameras may cause vignetting on the image.

Some Canon digital SLR cameras have index marks for attaching both EF lenses (red) and EF-S lenses (white) on the bayonet mount. To attach Tamron Di-II lenses, align the lens attachment mark on the lens (15) with the index mark for EF lenses (red). Do not forcibly align the indicator on the lens (15) with the index mark for EF-S lens (white). Doing so could result in damage to the lens and/or camera.

For further details, please read the instruction manual of your camera.

## FOCUSING (Autofocus) (Ref. Figs 1 & 2)

Switch the focusing mode switch of the camera to Auto focusing mode (AF) in case of Nikon, Konica Minolta, or Pentax. In case of Canon camera, switch the AF/MF switch (14) on the lens to AF. (Fig. 5). Press the shutter button lightly while viewing through the camera's viewfinder, the lens focuses automatically. An in-focus mark will light when the lens focuses on the main subject sharply. Press the shutter button further to photograph.

When set on AF mode, interfering with focusing ring (8) may cause serious damage to the lens mechanism.

For further details, please read the instruction manual of your camera.

## ZOOMING (Ref. Fig. 2)

Rotate zooming ring (9) of the lens while viewing through the camera's viewfinder and compose your image at the chosen focal length.

## ZOOM LOCK SWITCH (Ref. Figs. 3 & 4)

Model A16 is equipped with zoom lock switch mechanism which prevent lens barrel from extending towards long focal length, while hanging around the neck. Activate the switch at the shortest setting to stop the lens barrels from rotating and extending.

### How to activate the zoom lock switch mechanism

1. Locking: Set the zoom ring on the lens to the shortest position. Move the zoom lock switch (12) toward the camera for locking the zooming ring (9). The lens barrel is locked in position when the portion beneath "Lock" is shown in red and the lens barrel does not rotate or extend by its own weight.
2. Releasing: Push the zoom lock switch (12) up. The zooming ring (9) is now released and can be rotated.

Zoom lock switch cannot be activated unless the lens is set to the shortest position. Do not force the lock switch or try to rotate the zooming ring while locked; doing so may damage the lens.

The zoom lock mechanism is made to prevent the lens barrel from extending while carried around the neck. When not locked, the zoom lens may change its focal length during a long exposure used in a low or high angle position.

The lens can be used at the shortest setting for picture taking even while in the focused position.

## LENS APERTURE AND AE MODE

Please follow the instruction manual of your camera.

## LENS HOOD (Ref. Figs. 1, 7, 8, 9)

A bayonet-type lens hood is provided as standard equipment. We recommend shooting with the hood attached whenever possible as the lens hood eliminates stray light which is harmful to the picture. However, please be aware of the precautions written below when your camera is equipped with a built-in flash.

### Attaching the Lens Hood (Ref. Figs. 7 & 8)

Align the index mark (2) on the hood with the corresponding index mark (5) or the top of the index line of the distance scale, on the lens. Press the hood lightly onto the hood attaching bayonet ring (Fig. 7, No. 1) and then rotate it clockwise to secure (Fig. 7, No. 2). The lens hood will be securely held as the mark "TAMRON O" comes to the top (Fig. 8, No. 3). When attaching the lens hood, hold the focusing and zoom control rings so that they are not rotated unintentionally.

Pay particular attention to align the hood attaching indexes when using zoom lenses including wide-angle (ex. 35mm or wider) settings. Improper attachment of a hood for wide-angle zoom lens may cause large shadowed areas in your pictures.

## Stowing lens hood on the lens (Ref. Fig. 9)

1. Reverse the lens hood. Point the lens toward the opening, then align the hood attachment mark on the lens with the (TAMRON O) alignment on the hood (3).
2. Turn the hood clockwise until its alignment mark is at the top to set it. (Fig. 9, 2)

## PRECAUTIONS IN SHOOTING

The optical design for Di-II takes into consideration the various features of digital single reflex cameras. However, due to the configuration of the digital SLR cameras, even when the Autofocus accuracy is within specifications, the focal point may be a little forward or behind the optimum point when shooting with auto focus under some conditions.

The image circles of Di-II lenses are designed to match the digital SLR cameras using the image sensors equivalent to APS-C (approx. 15.5 x 23.2mm). Do not use Di-II lenses with such cameras may cause vignetting on the image.

A13 employs an internal focusing (IF) system. Because of the characteristics of this optical design, the angles of view at distances other than infinity are wider than that of the lenses applying an ordinary focusing system.

When the built-in flash on the camera is used, adverse photographic phenomena such as corner illumination, fall-off, or vignetting at the bottom part of the image may be observed, especially with wide angle ranges. This is due to the inherent limitation of the coverage of the built-in flash, and/or the relative position of the flash to the edge of the lens barrel which causes shadows on the image. It is strongly recommended to use a suitable separate flash unit provided by the camera manufacturer for all flash photography.

When using the lens in the telephoto focal range, please be careful with the camera shake. Effective way to avoid the camera shake is using an ISO setting of higher numbers. Using a tripod or monopod is also effective.

When set on AF mode, interfering with the focusing ring may cause serious damage to the lens mechanism.

Certain camera models may indicate the maximum and minimum aperture values of the lenses appropriate numbers. This is inherent to the design of the camera and not an indication of error.

When using a special filter such as a PL filter on the A16, use low-profile filters. The thick rim of a normal filter may cause vignetting.

## TO ENSURE LONG-TERM SATISFACTION

Avoid touching the glass element surface. Use a photographic lens cloth or a blower to remove dust from the lens element surface. When not using the lens, always place a lens cap on it for protection.

Use a lens cleaning tissue or lint cloth with a drop of cleaning solution to remove fingerprints or dirt on the glass lens surface with a rotary motion from the center to the edges.

Use a silicon cloth to clean your lens barrel only.

Mildew is an enemy of your lens. Clean the lens after shooting near water or in any humid place. Store your lens in a clean, cool, dry place. When storing your lens in a lens case, store it with commercially available drying agents such as silica gel, and change the agent occasionally. If you find mildew on your lens, consult an authorized repair shop or nearby photographic store.

Do not touch the lens-camera interface contacts since dust, dirt and/or stains may cause a contact failure between the lens and camera.

When using your equipment in an environment where the temperature changes from one extreme to another, make sure to put your equipment temporarily in a case or a plastic bag for a length of time in order for the equipment to go through a gradual temperature. This will reduce potential equipment trouble.