

TAMRON®

SP 24-70mm F/2.8

Di VC USD for Nikon & Canon (Model A007)

SP 24-70mm F/2.8

Di USD for Sony (models without the VC) (Model A007)

Thank you for purchasing the Tamron lens as the latest addition to your photographic equipment. Before using your new lens, please read the contents of this Owner's Manual thoroughly to familiarize yourself with your lens and the proper photographing techniques for creating the highest quality images possible. With proper handling and care, your Tamron lens will give you many years of photographing beautiful and exciting pictures.

NOMENCLATURE (Refer to Fig. 1, if not specified)

1. Lens hood
2. Hood attaching alignment mark
3. Hood attaching indicator
4. Filter ring
5. Hood attaching bayonet ring
6. Focusing ring
7. Distance scale
8. Distance index
9. Zooming ring
10. Focal length scale
11. Zoom lock switch (Figs. 3 & 4)
12. VC (Vibration Compensation) Switch
13. AF/MF switch (Figs. 5 & 6)
14. Zoom index mark
15. Lens attachment mark
16. Lens mount/Lens mount contacts

SPECIFICATIONS

	A007
Focal Length	24-70mm
Maximum Aperture	F/2.8
Angle of View	84° 04' - 34° 21'
Lens Construction	12/17
Minimum Focus Distance	0.38m (14.9")
Maximum Magnification Ratio	1:5 (at 70mm)
Filter Size	82mm
Length/Overall Length*	108.5mm (4.3") / 116.9mm (4.6")*
Diameter	88.2mm (3.5")
Weight	822 g (29oz)
Lens Hood	HA007

*Values are specifications of Nikon products. Length: From the lens front extremity to the mount surface. Overall length: From the lens front extremity to the rear projection extremity. Features and appearance of lenses listed in this owner's manual are subject to change without notice.

1

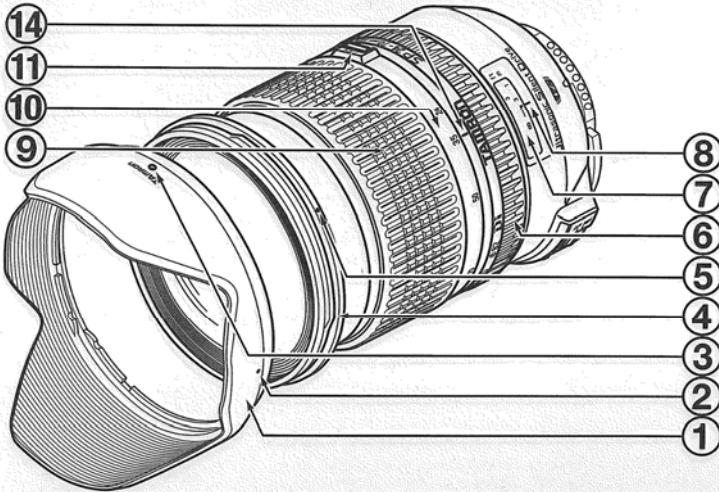

Nikon

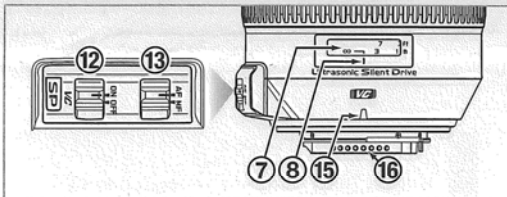

* A007: This model is Built-in Motor

Canon

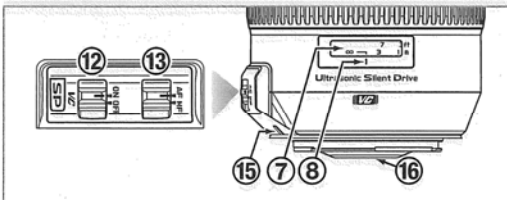

Sony

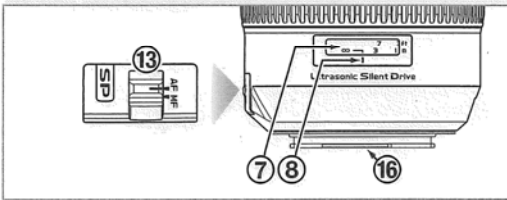

* Common with the Konica Minolta α mount.

2



3

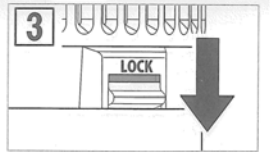

4

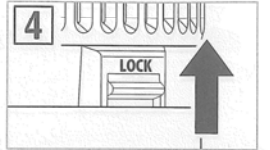

5

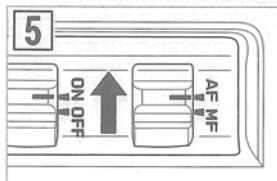

6

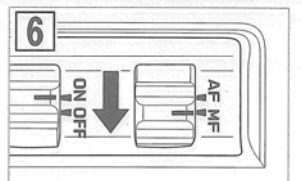

7

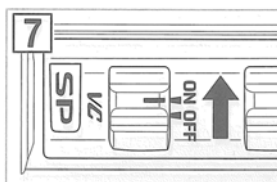

8

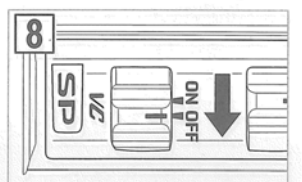

9

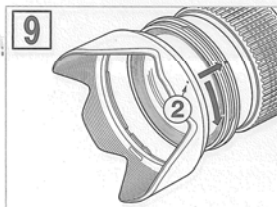

10

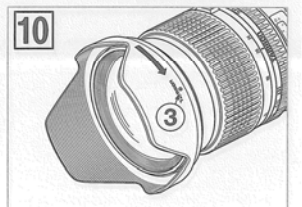

11

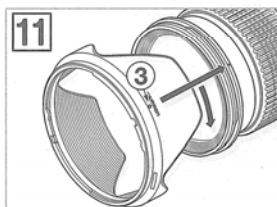

ATTACHING AND REMOVING THE LENS

- *How to mount the lens*

Removing the rear cap of the lens, align the lens attachment mark (15) on the lens barrel with its counterpart on the camera mount and insert the lens. Rotate the lens clockwise until it click-locks. For Nikon models, align the lens attachment mark with the dot on the camera and rotate the lens counter-clockwise until it click-locks.

- *How to detach the lens*

Pressing the lens release button on the camera down, turn the lens counter-clockwise (clockwise in case on Nikon), and lift the lens off the camera's lens mount.

* For further details, please read the instruction manual of your camera.

FOCUSING (Autofocus) and using the full-time manual function

In case of a Nikon or Canon, switch the AF/MF switch (13) on the lens to AF (fig. 5). In case of a Nikon camera with the focus mode selector dial, set the focus mode to S or C, and then set the AF/MF switch (13) on the lens to AF.

Press the shutter button halfway down while viewing through the camera's viewfinder. The lens focuses automatically. An in-focus mark will light on the LCD when lens focuses on the main subject sharply. Press the shutter button further to photograph.

In case of a Sony camera, switch the AF/MF switch (13) on the lens to AF (fig. 5), and set the focus mode on the camera to Auto focus (AF).

Press the shutter button halfway down while viewing through the camera's viewfinder, the lens focuses automatically. An in-focus mark will light when lens focuses on the main subject sharply. Press the shutter button further to photograph.

- *Using the full-time manual function?*

A007 is equipped with the full-time manual function.

The full-time manual function is a function that the focus can be fine-tuned by the manual focus without switching the AF/MF changing switch when taking a picture of auto focus.

- *How to use the full-time manual function*

First, set the focus mode to "AF"

You can adjust focus manually while turning the focus ring as the shutter button is pressed lightly.

The distance scale (7) is marked for guidance purposes. The actual focal point may slightly differ from the distance marked on the focal length index.

* For further details, please read the instruction manual of your camera.

FOCUSING (Manual Focus) (Ref. Fig. 1, 2 & 6)

In case of Nikon or Canon camera, switch the AF/MF switch (13) on the lens to MF (fig. 6). In case of a Nikon camera with the focus mode selector dial, set the focus mode to M, and then set the AF/MF switch (13) on the lens to MF. Focus manually rotating the focusing ring (6) while viewing through the camera's viewfinder (fig. 2). The main subject in the viewfinder will be sharp when the lens is focused correctly.

In case of a Sony camera, switch the AF/MF switch (13) on the lens to MF (fig. 6), and set the focus mode on the camera to Manual focus (MF). Focus manually rotating the focusing ring (6) while viewing through the camera's viewfinder (fig. 2). The main subject in the viewfinder will be sharp when the lens is focused correctly.

- Even in the MF mode, when turning the focusing ring (6) while pressing the shutter button halfway, the focus aid function lamp lights up when the picture is in focus.

- At infinity, make sure the image in the viewfinder appears sharp. The infinity position is made with certain allowances to insure proper focus under a variety of conditions.
- For further details, please read the instruction manual of your camera.

VC MECHANISM (Ref. Figs. 1, 7 & 8) (Mounted for Nikon & Canon models)

VC (Vibration Compensation) is a mechanism which reduces the image blur caused by hand-held shooting. When using the VC, pictures can be taken at shutter speeds up to a maximum of 4 stops slower than the speed when the VC is not used.

*Based on the company's standard measurement. Also, the correction of image blur differs depending on the conditions during picture taking and the person using the camera.

** How to use VC mechanism*

1. Set the VC switch (12) on.

*When VC is not used, set the switch off.

2. Press the shutter button halfway to verify the effect of the VC. When the shutter button is pressed down halfway, it takes about 1 second for the VC to provide a stable image.

** The VC can be effective for hand-held shots under the following conditions:*

- Dimly lit locations
- Scenes where flash photography is forbidden
- Situations where footing is uncertain
- Taking panning shots of a moving subject

** The VC may not be able to give full effect in the following cases:*

- When a photograph is taken from a fast moving vehicle
- Shooting during the excessive movement of the camera
- Turn the VC switch OFF when taking pictures with the bulb setting or during long exposures. If the VC switch is ON, the VC mechanism may introduce errors.

- *With the VC mechanism, there are occasions that the image in the viewfinder blurs right after the shutter button is pressed down halfway, but this is not a malfunction.*
- *When the VC switch is turned ON, the number of images recordable is reduced due to the power used from the camera.*
- *When the VC switch is turned ON, immediately after the shutter button is pushed halfway down and approximately 2 seconds after a finger releases the shutter button, the camera will "click". This sound is the VC's locking mechanism activating, it is not a malfunction.*
- *Turn the VC switch OFF when using a tripod.*
- *After releasing the shutter button, the VC will continue to operate for about 2 seconds until the locking mechanism activates.*
- When the lens is removed from the camera while VC is activating, the lens may make a clicking sound when the lens is subjected to a jolt. This is not a malfunction. Re-attach the lens to the camera and turn the power ON. The sound should stop.
- The VC activates while the "release" button is pushed halfway down. (It is activated 2 seconds after the shutter button is released.)

- VC can be used in AF or MF mode.
- For further details, please read the instruction manual of your camera.

ZOOMING (Ref. Fig. 1 & 2)

- Rotate the zooming ring (9) of the lens while viewing through the camera's viewfinder and compose your image at the chosen focal length.

ZOOM LOCK SWITCH (Ref. Fig 1, 3 & 4)

Zoom lock switch mechanism prevents lens barrels from extending toward long focal length by their own weight while hanging from shoulders. Activate the switch at 24mm setting to stop the lens barrels from rotating and extending.

How to activate the zoom lock switch mechanism

1. **Locking:** Set the lens to the 24mm position. Move the switch (11) toward the camera, until the index lines align with each other. The lens barrel is now locked in position and does not rotate or extend by its own weight.
 2. **Releasing:** Push the switch (11) away from the camera. The lens barrel is now free to rotate and extend for zooming.
- *The zoom lock switch (11) cannot be activated unless the lens is set to the 24mm position. Do not force the lock switch or try to rotate the lens barrel while locked.*
 - *The zoom lock mechanism is made to prevent the lens barrel from extending while carried around on the shoulder. The lens may change its focal length by its own weight during a long exposure if the lens is used at a high upward or downward angle with a focal length other than 24mm.*
 - The lens can be used at 24mm setting for picture taking even when locked by the switch.

LENS HOOD (Ref. Figs. 1, 9 & 11)

A bayonet-type lens hood is provided as standard equipment. We recommend shooting with the hood attached whenever possible as the lens hood eliminates stray light, which is harmful to the picture. However, please be aware of the precautions stated in the next section when your camera is equipped with a built-in flash.

Attaching the Lens Hood (Ref. Fig 9 & 10)

Align Hood attaching alignment mark (2) on the hood with the corresponding index mark (5) or the top of the index line of the distance scale of the lens. Press the hood lightly onto the hood attaching bayonet ring (Fig. 9) and then rotate it clockwise to secure. The lens hood will be secure when the mark "TAMRON O" is at the top (Fig. 10). When attaching the lens hood, hold the focus and zoom control rings, so they are not rotated unintentionally.

- *Pay particular attention to align the hood attaching indexes when using zoom lenses including wide-angle settings. Improper attachment of a hood on a wide-angle zoom lens may cause large shadowed areas in your pictures.*

Stowing lens hood on the lens (Ref. Fig 11)

Reverse the lens hood. Point the lens toward the opening, and then align the hood attaching index on the lens with the "TAMRON O" alignment on the hood. (3) Turn the hood clockwise until the alignment mark is at the top to set it. (Fig. 11)

PRECAUTIONS IN SHOOTING

-The optical design for Di takes into consideration the various features of digital single reflex cameras. However, due to the configuration of the digital single reflex cameras, even when autofocus accuracy is within specifications, the focal point may be a little forward or behind the optimum point when shooting with autofocus under some conditions.

-The Tamron lenses described here employ an internal focusing (IF) system. Because of the characteristics of this optical design, the angles of view at distances other than infinity are wider than that of the lenses applying an ordinary focusing system.

-When the built-in flash on the camera is used, adverse photographic phenomena such as corner illumination fall-off or vignetting at the bottom part of the image may be observed, especially in wide angle ranges. This is due to the inherent limitation of the coverage of the built-in flash, and/or the relative position of the flash to the edge of the lens barrel which causes shadows on the image. It is strongly recommended to use a suitable separate flash unit provided by the camera manufacturer for all flash photography.

-For further details, please read the "built-in flash" article on the instruction manual of your camera.

-Certain camera models may indicate the maximum and minimum aperture values of the lens in approximate numbers. This is inherent to the design of the camera and not an indication of an error.

-Please be aware that there is no infrared index line on an models listed in this owner's manual, and therefore, practically, no black-and-white infrared film can be used with these lenses.

-When using a special filter such as a PL filter, use low profile filters. The thick rim of a normal filter may cause vignetting.

TO ENSURE LONG-TERM SATISFACTION

-Avoid touching the glass element surface. Use a photographic lens cloth or blower to remove dust from the lens element surface. When not using the lens, always place a lens cap on it for protection.

-Use a lens cleaning tissue or lint cloth with a drop of cleaning solution to remove fingerprints or dirt on the glass lens surface with a rotary motion from the center to the edge.

- Use a silicon cloth to clean your lens barrel only.

-Mildew is an enemy of your lens. Clean the lens after shooting near water or in any humid place. Store your lens in a clean, cool, dry place. When storing the lens in a lens case, store it with commercially available drying agents such as silicagel, and change the agent occasionally. If you find mildew on your lens, consult an authorized repair shop or nearby photographic store.

-Do not touch the lens-camera interface contacts since dust, dirt and/or stains may cause a contact failure between the lens and camera.

-When using your equipment [camera(s) and lens(es)] in an environment where the temperature changes from one extreme to the other, make sure to put your equipment temporarily in a case or plastic bag for a length of time in order for the equipment to go through a gradual temperature shift. This will reduce potential equipment trouble.