

作成承認印

配布許可印



# AF-S DX Nikkor ED 18-55/3.5-5.6G

JAA79201 Silver

JAA79251 Black

## PARTS LIST 修理部品表

**Nikon** | NIKON CORPORATION  
Tokyo, Japan

Copyright © 2005 by Nikon Corporation.  
All Rights Reserved.  
無断転載を禁ず!!

A

B

JAA79201-R.3669.A

☆ ブラック部品

☆ Black Part

1

2

3

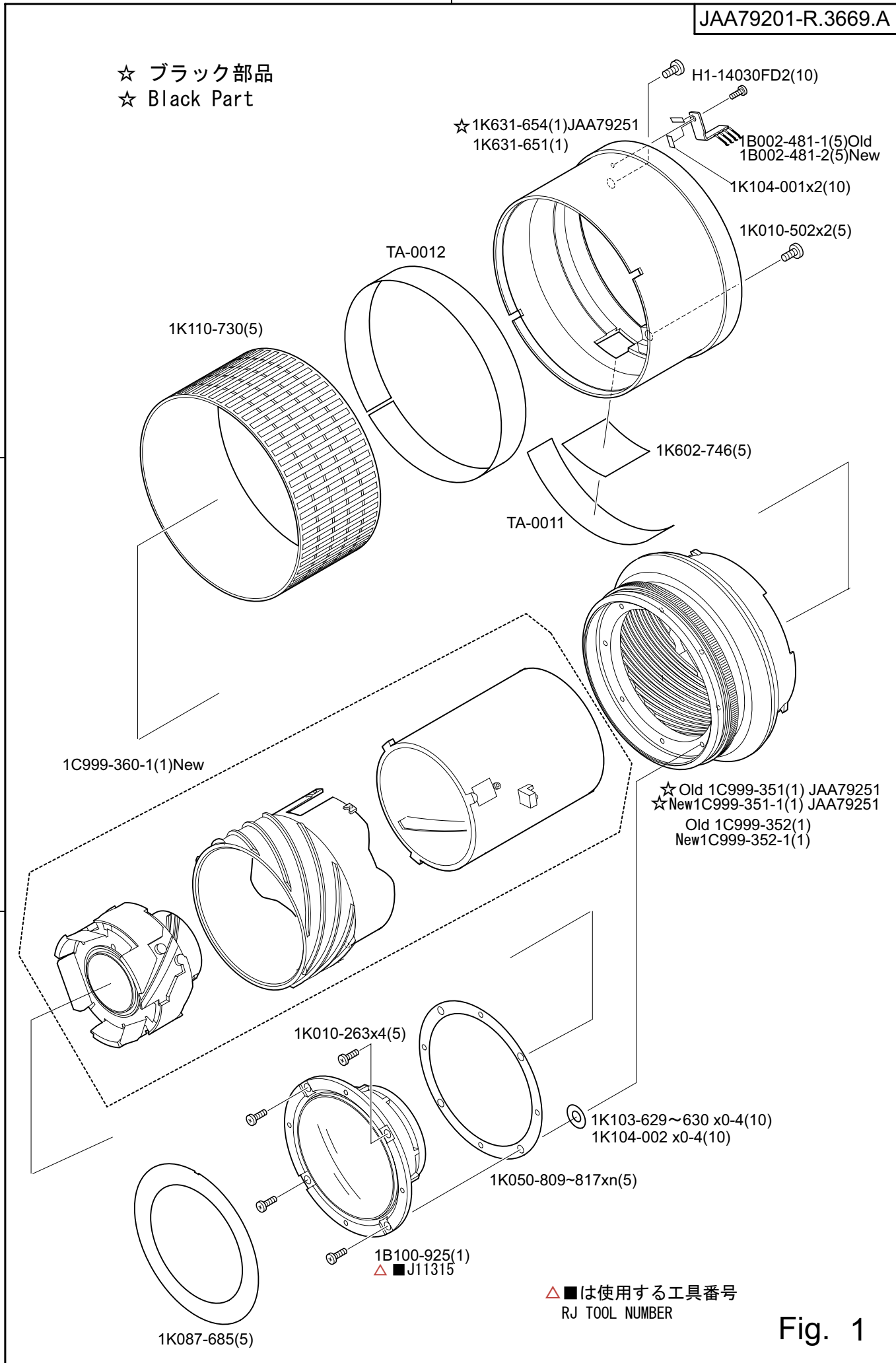

Fig. 1

A

B

JAA79201-R.3669.A

☆ ブラック部品  
☆ Black Part

1

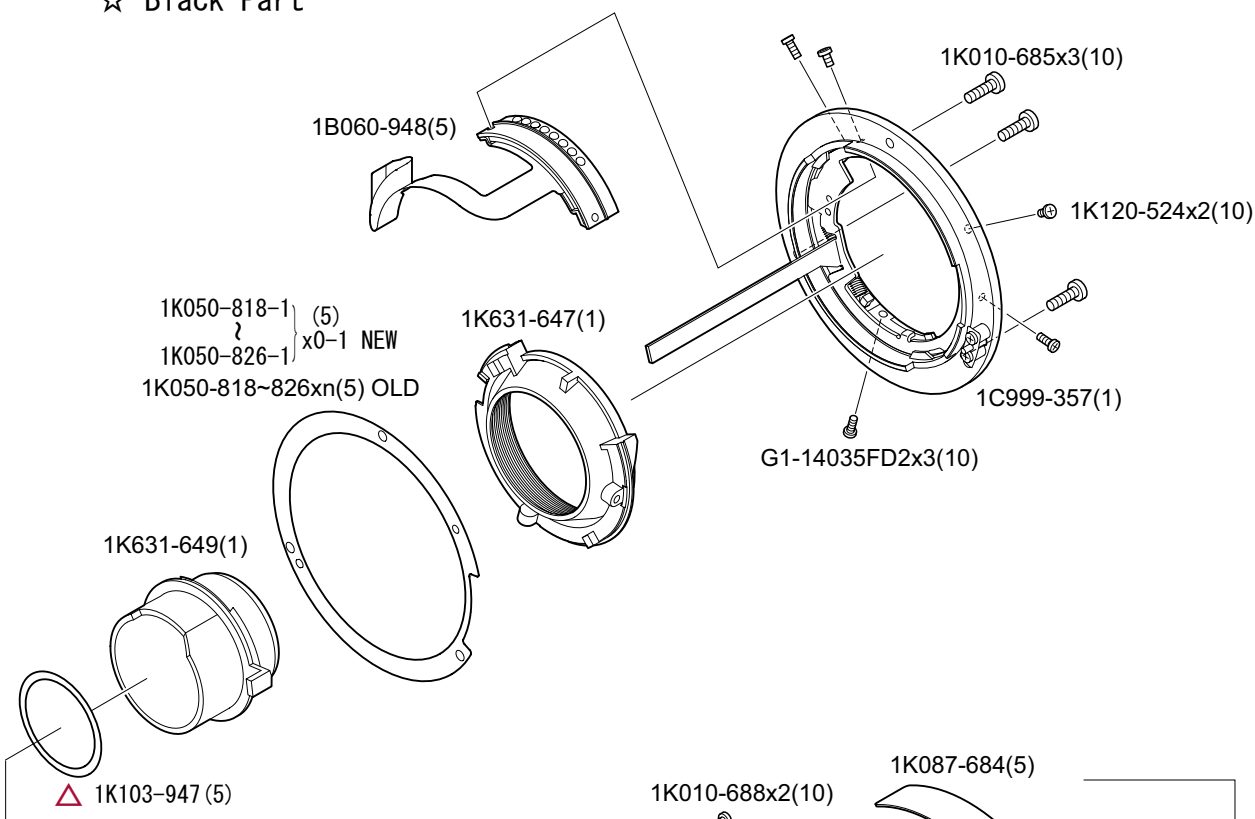

2

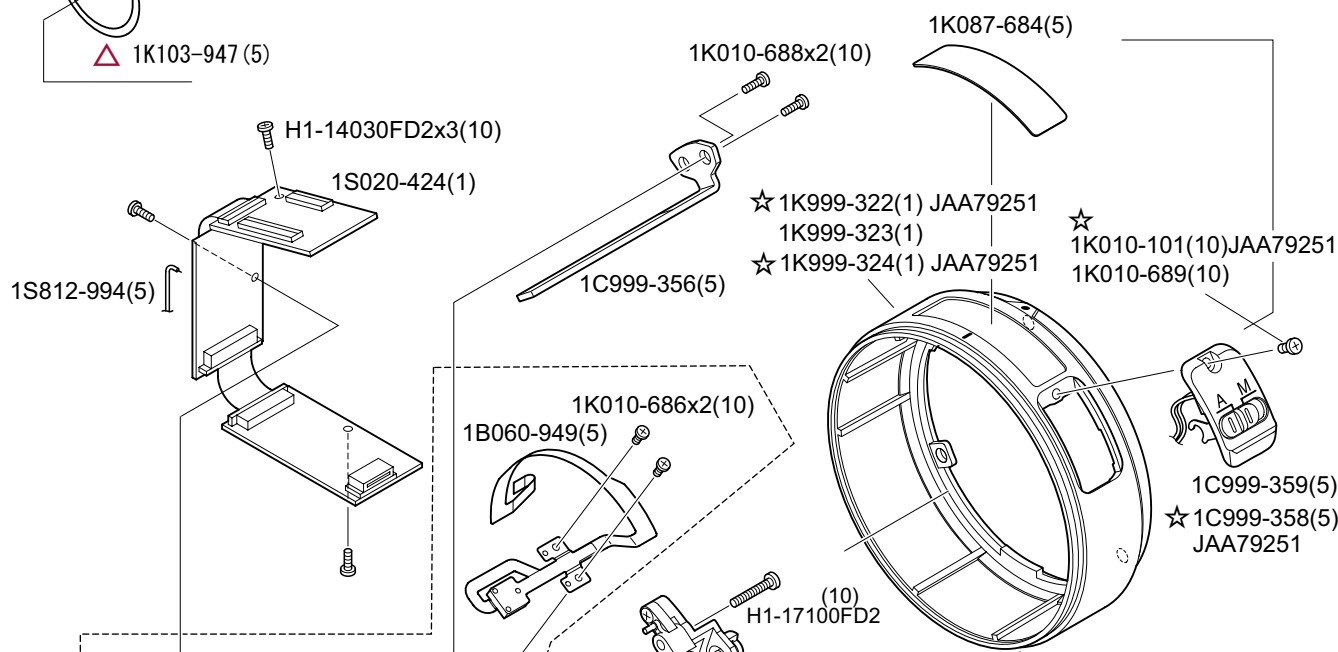

3

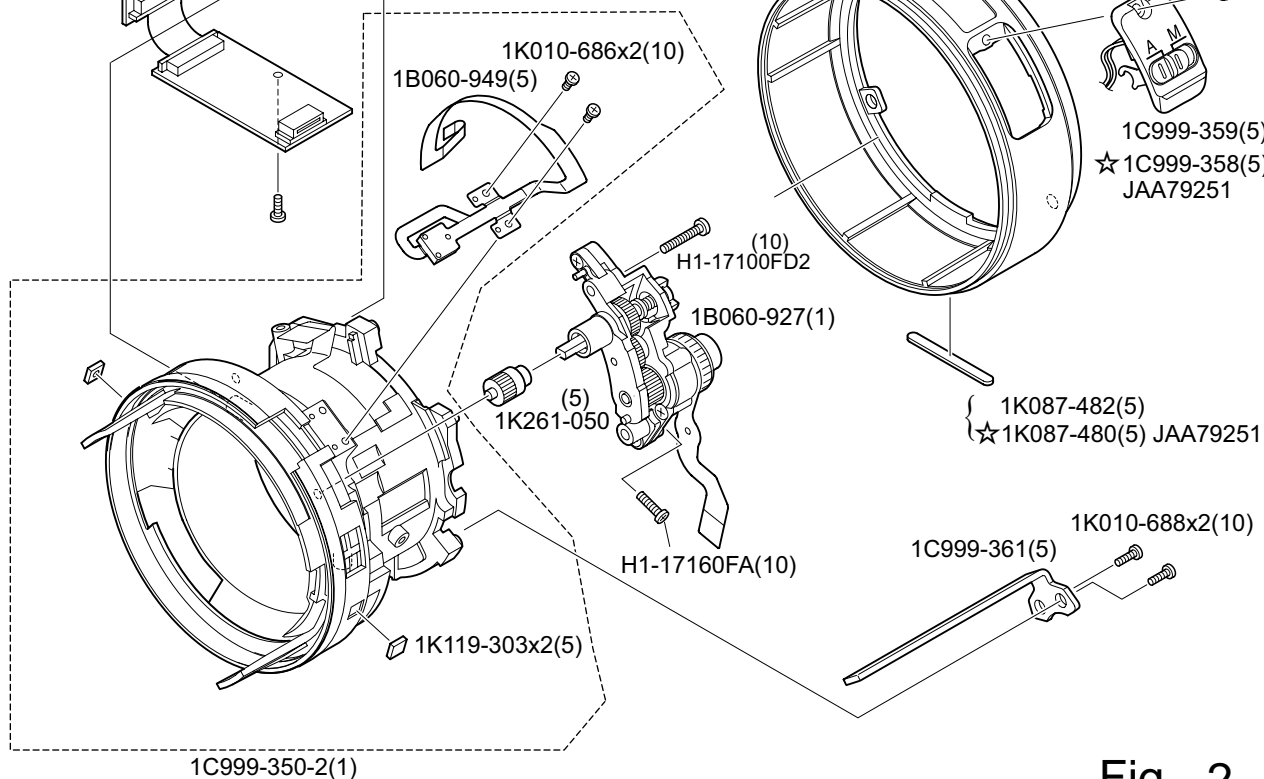

Fig. 2

## Parts List

AF-S DX 18-55/3.5-5.6G





























JAA79201-R.3669.A

Part Number Part Code	Barcode (Part Code)	部品名 Part Name	Pcs./ Unit	fig No.	Main Assembly	Q'ty/ Order	Remarks
△ 1B002-481 1B002-481		ズームブラシ部組 ZOOM BRUSH UNIT	1	1		5	RP0635
1B060-927 1B060-927		SWM部組 SWM UNIT	1	2		1	
1B060-948 1B060-948		接点部組 CONTACT UNIT	1	2		5	
1B060-949 1B060-949		GMR部組 GMR UNIT	1	2		5	
1B100-925 1B100-925		1群部組 1st LENS HOUSING UNIT	1	1		1	
△ 1C999-350 1C999-350		固定筒部組 FIXED TUBE UNIT	1	2		1	RP0635
△ 1C999-352 1C999-352		フィルター環(シルバー) FILTER RING UNIT (Silver)	1	1		1	RP0635 Old
1C999-356 1C999-356		直進キー部組A KEY UNIT A	1	2		5	
1C999-357 1C999-357		バヨネットマウント部組 BAYONET MOUNT UNIT	1	2		1	
1C999-359 1C999-359		A/M切替SW部組(シルバー) A/M CHANGE SW UNIT (Silver)	1	2		5	
△ 1C999-360 1C999-360		2群部組 2nd LENS HOUSING UNIT	1	1		1	RP0635
1C999-361 1C999-361		直進キー部組B KEY UNIT B	1	2		5	
* 1K010-263 1K010-263		SCREW SCREW	4	1		5	
* 1K010-502 1K010-502		SCREW SCREW	2	1		5	
1K010-685 1K010-685		SCREW SCREW	3	2		10	
1K010-686 1K010-686		SCREW SCREW	2	2	1C999-350-2	10	
1K010-688 1K010-688		SCREW SCREW	4	2		10	

## Parts List

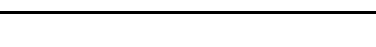
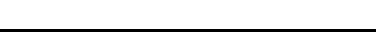
AF-S DX 18-55/3.5-5.6G

JAA79201-R.3669.A

Part Number Part Code	Barcode (Part Code)	部品名 Part Name	Pcs./ Unit	fig No.	Main Assembly	Q'ty/ Order	Remarks
1K010-689		SCREW	1	2		10	
1K010-689		SCREW					
1K050-809		振り分けワッシャー T=0.05	0-1	1		5	
1K050-809		WASHER (T=0.05)					
1K050-810		振り分けワッシャー T=0.06	0-1	1		5	
1K050-810		WASHER (T=0.06)					
1K050-811		振り分けワッシャー T=0.07	0-1	1		5	
1K050-811		WASHER (T=0.07)					
1K050-812		振り分けワッシャー T=0.08	0-1	1		5	
1K050-812		WASHER (T=0.08)					
1K050-813		振り分けワッシャー T=0.09	0-1	1		5	
1K050-813		WASHER (T=0.09)					
1K050-814		振り分けワッシャー T=0.10	0-1	1		5	
1K050-814		WASHER (T=0.10)					
1K050-815		振り分けワッシャー T=0.20	0-1	1		5	
1K050-815		WASHER (T=0.20)					
1K050-816		振り分けワッシャー T=0.30	0-1	1		5	
1K050-816		WASHER (T=0.30)					
1K050-817		振り分けワッシャー T=0.50	0-1	1		5	
1K050-817		WASHER (T=0.50)					
* 1K050-818		BF調整ワッシャー T=0.05	0-1	2		5	△ OLD
1K050-818		WASHER (T=0.05)					RP06108
* 1K050-819		BF調整ワッシャー T=0.06	0-1	2		5	△ OLD
1K050-819		WASHER (T=0.06)					RP06108
* 1K050-820		BF調整ワッシャー T=0.07	0-1	2		5	△ OLD
1K050-820		WASHER (T=0.07)					RP06108
* 1K050-821		BF調整ワッシャー T=0.08	0-1	2		5	△ OLD
1K050-821		WASHER (T=0.08)					RP06108
* 1K050-822		BF調整ワッシャー T=0.09	0-1	2		5	△ OLD
1K050-822		WASHER (T=0.09)					RP06108
* 1K050-823		BF調整ワッシャー T=0.10	0-1	2		5	△ OLD
1K050-823		WASHER (T=0.10)					RP06108
* 1K050-824		BF調整ワッシャー T=0.20	0-1	2		5	△ OLD
1K050-824		WASHER (T=0.20)					RP06108

## Parts List

AF-S DX 18-55/3.5-5.6G

JAA79201-R.3669.A

Part Number Part Code	Barcode (Part Code)	部品名 Part Name	Pcs./ Unit	fig No.	Main Assembly	Q'ty/ Order	Remarks
* 1K050-825 1K050-825		BF調整ワッシャー T=0.30 WASHER (T=0.30)	0-1	2		5	△ OLD RP06108
* 1K050-826 1K050-826		BF調整ワッシャー T=0.50 WASHER (T=0.50)	0-1	2		5	△ OLD RP06108
* 1K087-482 1K087-482		原産国シール (MADE IN THAILAND)白 COUNTRY OF ORIGIN SEAL V	1	2		5	
1K087-684 1K087-684		銘板 NAME PLATE	1	2		5	
1K087-685 1K087-685		社名環 NAME RING	1	1		5	
1K110-730 1K110-730		ゴムリング RUBBER RING	1	1		5	
* 1K119-303 1K119-303		トルク出しゴム SILICONE RUBBER	2	2	1C999-350-2	5	
1K120-524 1K120-524		SCREW SCREW	2	2		10	
1K261-050 1K261-050		ギヤ GEAR	1	2	1C999-350-2	5	
1K602-746 1K602-746		距離ブラシ穴隠し板 COVER PLATE	1	1		5	
1K631-647 1K631-647		保護環 REAR COVER RING	1	2		1	
1K631-649 1K631-649		遮光環 LIGHT SHIELD RING	1	2		1	
1K631-651 1K631-651		ズーム環(シルバー) ZOOM RING (Silver)	1	1		1	
1K999-323 1K999-323		後部固定環(シルバー) INDEX RING (Silver)	1	2		1	
1S020-424 1S020-424		メイン基板部組 MAIN FPC UNIT	1	2		1	
1S812-994 1S812-994		リード線(白) LEAD WIRE	1	2		5	
G1-14035FD2 G1-14035FD2		SCREW SCREW	3	2		10	

Parts List

AF-S DX 18-55/3.5-5.6G

JAA79201-R.3669.A

Part Number Part Code	Barcode (Part Code)	部品名 Part Name	Pcs./ Unit	fig No.	Main Assembly	Q'ty/ Order	Remarks
H1-14030FD2		SCREW	4	1,2		10	
H1-14030FD2		SCREW					
* H1-17060FA		SCREW	1	2	1C999-350-2	10	
H1-17060FA		SCREW					
H1-17100FD2		SCREW	1	2	1C999-350-2	10	
H1-17100FD2		SCREW					
1B002-481-1		ズームブラシ部組	1	1		5	RP0635
1B002-481-1		ZOOM BRUSH UNIT					
1B002-481-2		ズームブラシ部組	1	1		5	RP0635
1B002-481-2		ZOOM BRUSH UNIT					
1C999-350-2		固定筒部組	1	2		1	RP0635
1C999-350-2		FIXED TUBE UNIT					
1C999-352-1		フィルター環(シルバー)	1	1		1	RP0635 New
1C999-352-1		FILTER RING UNIT (Silver)					
1C999-360-1		2群部組	1	1		1	RP0635
1C999-360-1		2nd LENS HOUSING UNIT					
1K103-629		ワッシャー T=0.10	0-4	1		10	RP0635
1K103-629		WASHER T=0.10					
1K103-630		ワッシャー T=0.15	0-4	1		10	RP0635
1K103-630		WASHER T=0.15					
△ * 1K103-947		遮光シート	1	2		5	RP07033
1K103-947		LIGHT SHIELD SHEET					
1K104-001		テープ	0-4	1		10	RP0635
1K104-001		TAPE					
1K104-002		ワッシャー T=0.05	0-4	1		10	RP0635
1K104-002		WASHER T=0.05					

Parts List

AF-S DX 18-55/3.5-5.6G

JAA79201-R.3669.A

Part Number Part Code	Barcode (Part Code)	部品名 Part Name	Pcs./ Unit	fig No.	Main Assembly	Q'ty/ Order	Remarks
△ * 1K050-818-1		BF調整ワッシャー T=0.05	0-1	2		5	NEW
1K050-818-1		WASHER (T=0.05)					RP06108
△ * 1K050-819-1		BF調整ワッシャー T=0.06	0-1	2		5	NEW
1K050-819-1		WASHER (T=0.06)					RP06108
△ * 1K050-820-1		BF調整ワッシャー T=0.07	0-1	2		5	NEW
1K050-820-1		WASHER (T=0.07)					RP06108
△ * 1K050-821-1		BF調整ワッシャー T=0.08	0-1	2		5	NEW
1K050-821-1		WASHER (T=0.08)					RP06108
△ * 1K050-822-1		BF調整ワッシャー T=0.09	0-1	2		5	NEW
1K050-822-1		WASHER (T=0.09)					RP06108
△ * 1K050-823-1		BF調整ワッシャー T=0.10	0-1	2		5	NEW
1K050-823-1		WASHER (T=0.10)					RP06108
△ * 1K050-824-1		BF調整ワッシャー T=0.20	0-1	2		5	NEW
1K050-824-1		WASHER (T=0.20)					RP06108
△ * 1K050-825-1		BF調整ワッシャー T=0.30	0-1	2		5	NEW
1K050-825-1		WASHER (T=0.30)					RP06108
△ * 1K050-826-1		BF調整ワッシャー T=0.50	0-1	2		5	NEW
1K050-826-1		WASHER (T=0.50)					RP06108



Parts List

AF-S DX 18-55/3.5-5.6G

JAA79251-R.3669.A

Part Number Part Code	Barcode (Part Code)	部品名 Part Name	Pcs./ Unit	fig No.	Main Assembly	Q'ty/ Order	Remarks
△ 1C999-351 1C999-351		フィルター環(黒) FILTER RING UNIT (Black)	1	1		1	RP0635 Old
1C999-358 1C999-358		A/M切替SW部組(黒) A/M CHANGE SW UNIT (Black)	1	2		5	
* 1K010-101 1K010-101		SCREW SCREW	1	2		10	
* 1K087-480 1K087-480		原産国シール(M/T) 黒 LABEL SEAL V (Black)	1	2		5	
1K631-654 1K631-654		ズーム環(黒) ZOOM RING (Black)	1	1		1	
1K999-322 1K999-322		後部固定環(黒) INDEX RING (Black)	1	2		1	
1K999-324 1K999-324		後部固定環(黒)US INDEX RING (Black)US	1	2		1	
△ 1C999-351-1 1C999-351-1		フィルター環(黒) FILTER RING UNIT (Black)	1	1		1	RP0635 New