

Canon EF LENS

EF70-200mm f/4L USM



ENG

Instruction

ULTRASONIC

Thank you for purchasing a Canon product.

The Canon EF70-200mm f/4L USM lens is a compact, high-performance telephoto zoom lens for Canon EOS cameras.

- "USM" stands for Ultrasonic Motor.

Features

1. With fluorite and UD lens elements, outstanding image delineation is obtained.
2. Ultrasonic motor (USM) for quick and quiet autofocus.
3. Manual focusing is available after the subject comes into focus in autofocus mode (ONE SHOT AF).
4. The lens is compatible with Extender EF1.4X II and EF2X II.

Conventions used in this instruction



Warning to prevent lens or camera malfunction or damage.



Supplementary notes on using the lens and taking pictures.

Safety Precautions

Safety Precautions

- **Do not look at the sun or a bright light source through the lens or camera.** Doing so could result in loss of vision. Looking at the sun directly through the lens is especially hazardous.
- **Do not point the lens or camera at the sun or photograph it.** This is because the lens concentrates the sun's rays even when the sun is outside the image area or when shooting with backlight, which could cause malfunction or fire.
- **Whether it is attached to the camera or not, do not leave the lens under the sun without the lens cap attached.** This is to prevent the lens from concentrating the sun's rays, which could cause a fire.

Handling Cautions

- **If the lens is taken from a cold environment into a warm one, condensation may develop on the lens surface and internal parts.** To prevent condensation in this case, first put the lens into an airtight plastic bag before taking it from a cold to warm environment. Then take out the lens after it has warmed gradually. Do the same when taking the lens from a warm environment into a cold one.
- Do not leave the lens in excessive heat such as in a car in direct sunlight. **High temperatures can cause the lens to malfunction.**

This device complies with Part 15 of the FCC Rules. Operation is subject to the following two conditions: (1) This device may not cause harmful interference, and (2) this device must accept any interference received, including interference that may cause undesired operation.

Do not make any changes or modifications to the equipment unless otherwise specified in the instructions. If such changes or modifications should be made, you could be required to stop operation of the equipment.

This equipment has been tested and found to comply with the limits for a class B digital device, pursuant to part 15 of the FCC Rules. These limits are designed to provide reasonable protection against harmful interference in a residential installation. This equipment generates, uses and can radiate radio frequency energy and, if not installed and used in accordance with the instructions, may cause harmful interference to radio communications.

However, there is no guarantee that interference will not occur in a particular installation. If this equipment does cause harmful interference to radio or television reception, which can be determined by turning the equipment off and on, the user is encouraged to try to correct the interference by one or more of the following measures:

- Reorient or relocate the receiving antenna.
- Increase the separation between the equipment and receiver.
- Consult the dealer or an experienced radio/TV technician for help.

This Class B digital apparatus complies with Canadian ICES-003.

Nomenclature

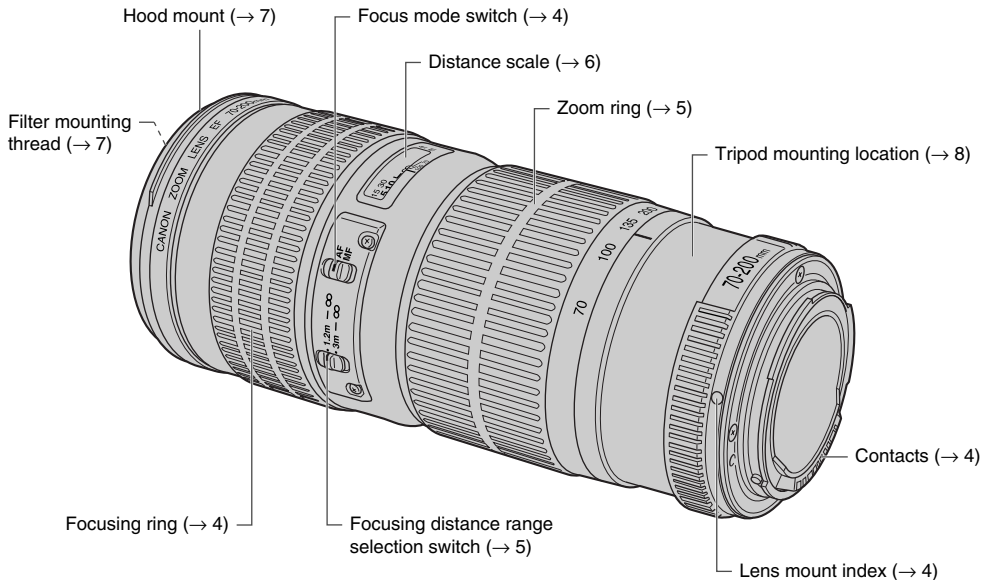

For detailed information, reference page numbers are provided in parentheses (→ **).

1. Mounting and Detaching the Lens

See your camera's instructions for instructions on mounting and detaching the lens.

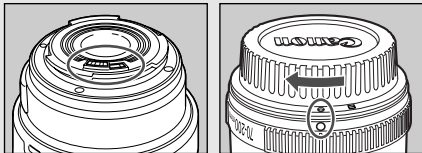

- After detaching the lens, place the lens with the rear end up to prevent the lens surface and electrical contacts from getting scratched.
- If the contacts get soiled, scratched, or have fingerprints on them, corrosion or faulty connections can result. The camera and lens may not operate properly.
- If the contacts get soiled or have fingerprints on them, clean them with a soft cloth.
- If you remove the lens, cover it with the dust cap. To attach it properly, align the lens mount index and the ○ index of the dust cap as shown in the diagram, and turn clockwise. To remove it, reverse the order.

2. Setting the Focus Mode

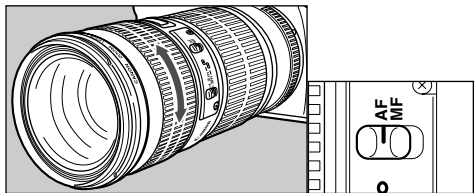

To shoot in autofocus (AF) mode, set the focus mode switch to AF.

To use only manual focusing (MF), set the focus mode switch to MF, and focus by turning the focusing ring. The focusing ring always works, regardless of the focus mode.



After autofocus in ONE SHOT AF mode, focus manually by pressing the shutter button halfway and turning the focusing ring. (Full-time manual focus)

3. Switching the Focusing Distance Range

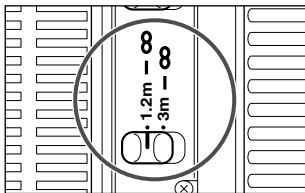

You can set the focusing distance range to 1.2 m/3.9 ft. to infinity or 3 m/9.8 ft. to infinity. By setting the suitable focusing distance range, the actual autofocus time can be shorter.

⚠ If the current focusing distance is not within the focusing distance range you switch to, the lens focusing may first stop at the start or end of the focusing range. This is normal and not a malfunction. Just press the shutter button halfway again to resume normal autofocus.

4. Zooming

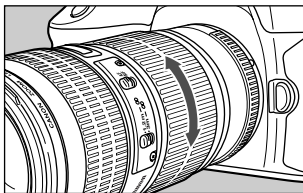

To zoom, turn the zoom ring.

⚠ Be sure to finish zooming before focusing. Changing the zoom ring after focusing can affect the focus.

5. Infinity Compensation Mark

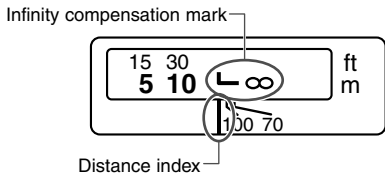

To compensate for shifting of the infinity focus point that results from changes in temperature. The infinity position at normal temperature is the point at which the vertical line of the L mark is aligned with the distance indicator on the distance scale.

 For accurate manual focusing on subjects at infinity distance, look through the viewfinder while rotating the focusing ring.

6. Infrared Index

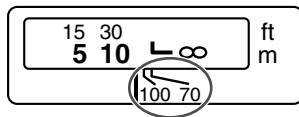

The infrared index corrects the focus setting when using monochrome infrared film. Focus on the subject manually, then adjust the distance setting by moving the focusing ring to the corresponding infrared index mark.

 Some EOS cameras cannot use infrared film. See the instructions for your EOS camera.

- 
- The infrared index position is based on a wavelength of 800 nm.
 - The compensation amount differs depending on the focal length. Use the indicated focal length as a guide when setting the compensation amount.
 - Be sure to observe the manufacturer's instructions when using infrared film.
 - Use a red filter when you take the picture.

7. Hood

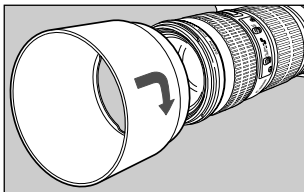

The ET-74 hood can keep unwanted light out of the lens, and also protects the front of the lens from rain, snow, and dust.

Attach and align the hood to the hood mount on the front of the lens, and turn the hood as shown by the arrow to secure it.

The hood can be reverse-mounted on the lens for storage.

- Part of the picture may be blocked if the hood is not attached properly.
- When attaching or detaching the hood, grasp the base of the hood to turn it. To prevent deformation, do not grasp the rim of the hood to turn it.

8. Filters (Sold Separately)

You can attach filters to the filter mounting thread on the front of the lens.

- If you need a polarizing filter, use the Canon Circular Polarizing Filter (67mm).
- To adjust the polarizing filter, first remove the lens hood.

9. Using the Tripod Mount (Sold separately)

Adjusting the Revolving Mount

This lens can be used with the A II (W) tripod mount ring, sold separately. You can loosen the orientation lock-knob on the tripod mount to allow it to rotate as needed to fit a particular camera model for switching between vertical and horizontal positions.

Detaching

Use the following procedures to remove and attach the tripod mount.

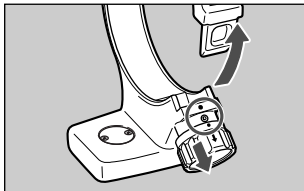

- 1 Turn the locking knob counterclockwise until it becomes loose (about 3 turns), and pull the knob in the direction of the arrow to release the collar.

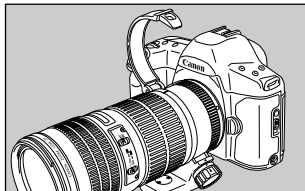

- 2 With the collar open, remove the tripod mount.

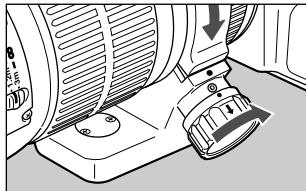

- 3 To install, while pulling the locking knob, bring the collar to the original position, and tighten the locking knob securely.

 The tripod collar can be attached to or detached from the lens while the lens is attached to the camera.

10. Extenders (Sold Separately)

With Extender EF1.4X II or EF2X II attached, the lens specifications will change as follows:

Item	With EF1.4X II Extender	With EF2X II Extender
Focal length (mm)	98 – 280	140 – 400
Aperture	f/5.6 – 45	f/8 – 64
Angle of view	Diagonal	25°20' – 8°50'
	Vertical	13°50' – 4°55'
	Horizontal	20°50' – 7°20'
Maximum magnification (×)	0.31	0.45

-  First attach the Extender to the lens, then attach the lens to the camera. Detach it from the camera in the reverse order. If you attach the lens to the camera first, misoperation may occur.
- With Extender EF2X II attached to the lens, only manual focus is possible. However, with the EOS-1Ds Mark III, EOS-1Ds Mark II, EOS-1Ds, EOS-1D Mark III, EOS-1D Mark II N, EOS-1D Mark II, EOS-1D, EOS-1V/HS, EOS-3 camera, autofocusing with the center focusing point is possible.
- Only one Extender can be attached to the lens and camera.
- If you use an Extender on the lens mounted on a EOS A2/A2E/5, set the exposure compensation to -1/2 stop for the EF1.4X II or -1 stop for the EF2X II.

-  Autofocusing is still enabled with Extender EF1.4X II attached.
- When an Extender is attached, the AF speed will become slower by design to retain proper AF control.

11. Extension Tubes (Sold Separately)

You can attach Extension Tube EF12 II or EF25 II for magnified shots. The shooting distance and magnification are shown below.

		Camera-to-Subject Distance (mm)		Magnification	
		Near	Far	Near	Far
EF12 II	70mm	554	639	0.23×	0.17×
	200mm	1015	3572	0.29×	0.06×
EF25 II	70mm	423	428	0.39×	0.35×
	200mm	901	1942	0.36×	0.13×



Manual focusing is recommended for accurate focusing.

Specifications

Focal Length & Max. Aperture	70 – 200 mm, f/4
Lens Construction	13 groups, 16 elements
Min. Aperture	f/32
Angle of View	Diagonal: 34° – 12° Vertical: 19°30' – 7° Horizontal: 29° – 10°
Min. Focusing Distance	1.2 m / 3.9 ft.
Max. Magnification & Field of view	0.21× (at 200 mm), 300 × 450 mm – 114 × 171 mm/11.7 × 17.6 inch – 4.46 × 6.7 inch (at 1.2 m)
Filter Diameter	67 mm
Max. Diameter & Length	76 × 172mm / 3.0 × 6.8 inch
Weight	705 g / 24 oz
Lens Hood	ET-74
Lens Cap	E-67U/E-67 II
Case	LP1224
Tripod Collar (Sold separately)	Ring-type tripod mounting socket A II (W)

- The lens length is measured from the mount surface to the front end of the lens. Add 21.5 mm to include the E-67U lens cap and dust cap, and 24.2 mm for the E-67 II.
- The size and weight listed are for the lens only, except as indicated.
- There is no size available among 250D/500D close-up lenses.
- Aperture settings are specified on the camera.
- All data listed is measured according to Canon standards.
- Product specifications and appearance are subject to change without notice.

Canon