

Canon EF LENS

TS-E17mm f/4L

TS-E24mm f/3.5L II



ENG

Instructions

Thank you for purchasing a Canon product.

Canon's TS-E lenses are tilt-shift lenses designed for EOS cameras. The tilt-shift mechanism enables photographers to control the depth of field and the area photographed and to correct image distortion, making it possible to take sophisticated pictures that cannot be shot using a conventional lens.

- To ensure that you make the most of the TS-E lens functionality, it is recommended that you shoot in the following conditions.
 - Use an EOS camera with 100% viewfinder visibility (EOS-1, EOS-1D or EOS-1Ds series) and use the laser matte with grid focusing screen Ec-D
 - Use Live View
 - Use a tripod
- On EOS cameras with a built-in flash, some partial restrictions may apply to the shift and rotation functions.

Features

1. Aspherical and UD lens elements result in outstanding image delineation.
2. SWC (Subwavelength Structure Coating) dramatically reduces ghosting and flare caused by light entering at an acute angle.
3. The lens can be tilted up to $\pm 6.5^\circ$ (for TS-E17mm f/4L) or $\pm 8.5^\circ$ (for TS-E24mm f/3.5L II), and shifted up to ± 12 mm.
4. The tilt and shift functions can be used singly or in combination. The tilt and shift can switch from right angle to parallel using the TS rotation feature.
5. The lens can be rotated to change the tilt or shift direction.
6. A truly round aperture hole results in a nicer background blur.



Safety Precautions



Safety Precautions

- **Do not look at the sun or a bright light source through the lens or camera.** Doing so could result in loss of vision. Looking at the sun directly through the lens is especially hazardous.
- **Whether it is attached to the camera or not, do not leave the lens under the sun without the lens cap attached.** This is to prevent the lens from concentrating the sun's rays, which could cause a fire.
- **To mount/detach the lens, always move the tilt and shift scales to "0".** Fingers may get caught, or the camera may be damaged.
- **When you tilt or shift the lens, sharp portions of the tilt or shift mechanism are exposed and care should be taken to avoid touching these portions.**
- **Do not operate the shift function while operating the rotation function.** You may be injured by having your fingers caught.

Handling Cautions

- **If the lens is taken from a cold environment into a warm one, condensation may develop on the lens surface and internal parts.** To prevent condensation in this case, first put the lens into an airtight plastic bag before taking it from a cold to warm environment. Then take out the lens after it has warmed gradually. Do the same when taking the lens from a warm environment into a cold one.
- Do not leave the lens in excessive heat such as in a car in direct sunlight. **High temperatures can cause the lens to malfunction.**

Safety Precautions

Countermeasures for harmful rays

The TS-E17mm f/4L has a wide angle of view, and the lens protrudes from the front frame, so it can be affected by harmful rays. To prevent flare and ghosting, cutting off the harmful rays entering the lens with a piece of cardboard is recommended.

Cutting off harmful rays is also recommended for TS-E24mm f/3.5L II, by using both the hood and the method used for TS-E17mm f/4L.

Conventions used in this instruction



Warning to prevent lens or camera malfunction or damage.



Supplementary notes on using the lens and taking pictures.

This device complies with Part 15 of the FCC Rules. Operation is subject to the following two conditions: (1) This device may not cause harmful interference, and (2) this device must accept any interference received, including interference that may cause undesired operation.

Do not make any changes or modifications to the equipment unless otherwise specified in the instructions. If such changes or modifications should be made, you could be required to stop operation of the equipment.

This equipment has been tested and found to comply with the limits for a class B digital device, pursuant to part 15 of the FCC Rules. These limits are designed to provide reasonable protection against harmful interference in a residential installation. This equipment generates, uses and can radiate radio frequency energy and, if not installed and used in accordance with the instructions, may cause harmful interference to radio communications.

However, there is no guarantee that interference will not occur in a particular installation. If this equipment does cause harmful interference to radio or television reception, which can be determined by turning the equipment off and on, the user is encouraged to try to correct the interference by one or more of the following measures:

- Reorient or relocate the receiving antenna.
- Increase the separation between the equipment and receiver.
- Consult the dealer or an experienced radio/TV technician for help.

This Class B digital apparatus complies with Canadian ICES-003.

Nomenclature

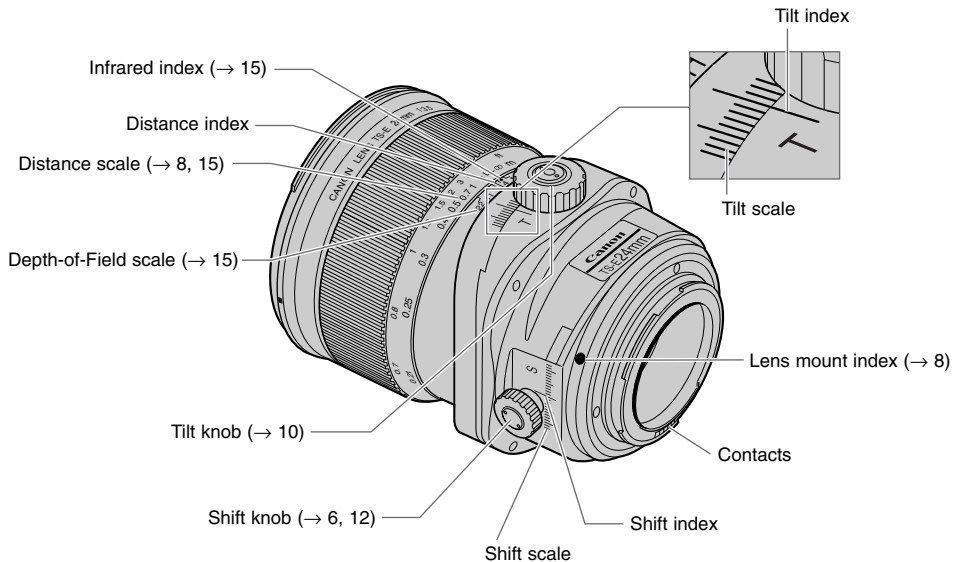

For detailed information, reference page numbers are provided in parentheses (→ **).

Nomenclature

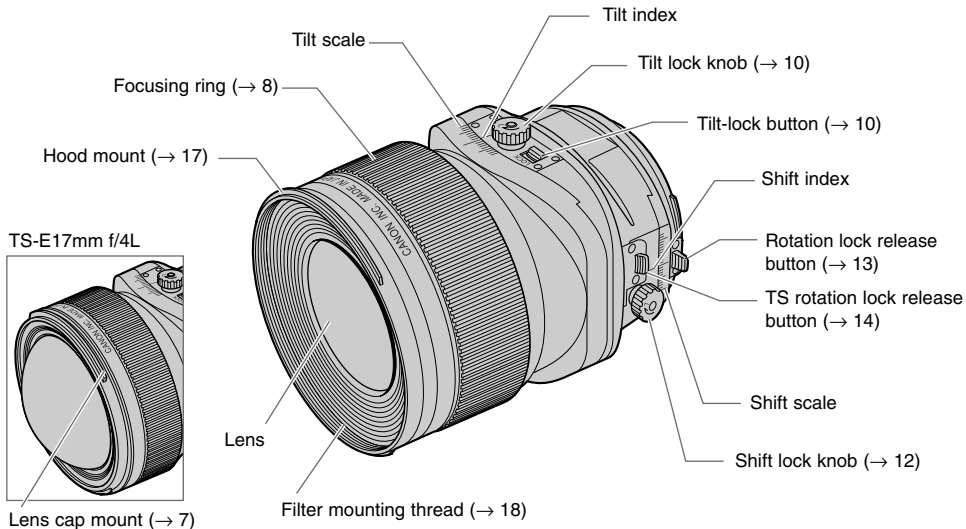

For detailed information, reference page numbers are provided in parentheses (→ **).

About the Shift Knob Cap

Shifting will be easier if the supplied shift knob cap is mounted (p.4).

However, for EOS cameras with built-in flash, the cap will come in contact with the camera during the lens' mounting/detaching, or during shift/rotation operation. The shift knob cap is recommended for use with EOS-1, EOS-1D, EOS-1Ds, and EOS 5D series.

Mounting screw
(Length 3mm)

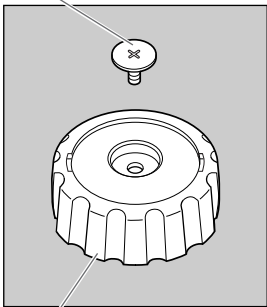

Shift knob cap

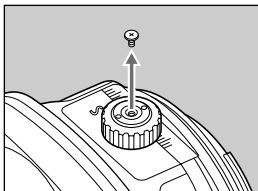

1 Remove the shift knob screw.

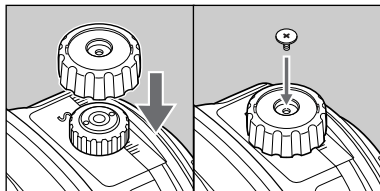

2 Mount the cap by squeezing it into the shift knob, and then fix it using the supplied screw.
To remove the cap, remove the screw and pull out the cap.

 The screw (length 2.2mm) originally in the shift knob cannot be used to keep the shift knob cap in place. Always use the supplied screw.

 Use a watchmaker's screwdriver (Phillips head type) to remove or mount screws.

Mounting/Removing the Lens Cap (TS-E17mm f/4L)

The lens of TS-E17mm f/4L protrudes from the front frame. To protect the lens, keep it covered with the exclusive lens cap when not shooting.

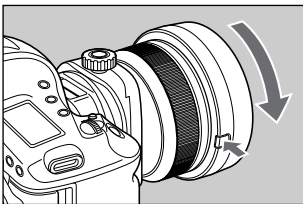

● Removing

To remove the cap, hold down the button on the side and turn the cap in the direction of the arrow until the position mark on the cap aligns with the red dot.

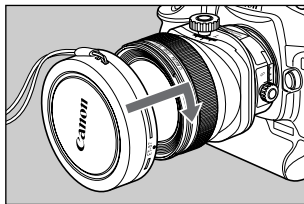

● Attaching

To attach the cap, align the cap's attachment position mark with the red dot on the front of the lens, then turn the cap as shown by the arrow until the lens' red dot is aligned with the cap's stop position mark.

 The removed lens cap can be hooked on the tripod using the supplied strap.

 Do not use the strap to lift the lens while the lens cap is attaching the lens. The lens may fall and break.

1. Mounting and Detaching the Lens

See your camera's instructions for details on mounting and detaching the lens.

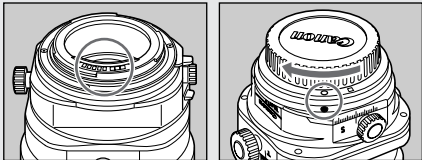

- When mounting or detaching the lens, always ensure that the tilt and shift scales are set to the “0” position.
- After detaching the lens, place the lens with the rear end up to prevent the lens surface and contacts from getting scratched.
- If the contacts get soiled, scratched, or have fingerprints on them, corrosion or faulty connections can result. The camera and lens may not operate properly.
- If the contacts get soiled or have fingerprints on them, clean them with a soft cloth.
- If you remove the lens, cover it with the dust cap. To attach it properly, align the lens mount index and the ○ index of the dust cap, and turn clockwise. To remove it, reverse the order.

2. Focusing

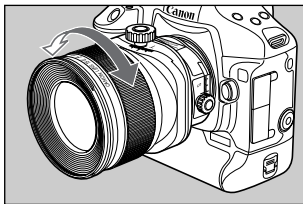

Focus a TS-E lens by turning the focusing ring. (Shots cannot be taken using the auto focus.)



- After using tilt or shift, readjust the focus.
- The distance scale is only valid when the tilt scale is set to the “0” position.



For cameras which allow Live View shooting, focusing using the LCD monitor's magnified image is recommended.

3. Tilt Function

Tilting inclines the lens relative to the image plane. When the tilt scale is set to the “0” position, the focusing and imaging planes are parallel. However, tilting puts the focusing plane at an angle to the imaging plane.

● Example 1

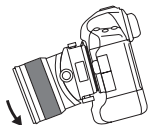

● Example 2

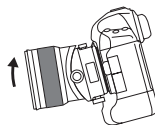

To shoot so that all of an extensive subject is in focus, you must normally use a small aperture to obtain a large depth of field. But tilting allows you to keep all of the subject in focus even when there is insufficient depth of field (Example 1). Or, by tilting in the opposite direction, you can focus on a specific part of the subject (Example 2).

Using Tilt

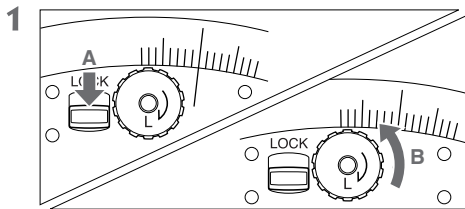

Slide the tilt-lock button in the direction of arrow A. Loosen the tilt lock knob by turning it in the direction of arrow B.

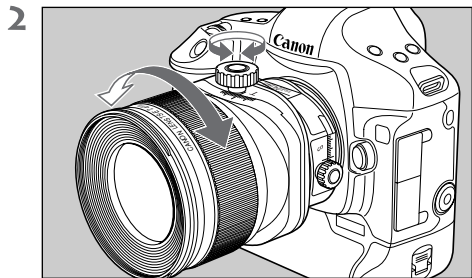

Turn the tilt knob to adjust the amount of tilt. Focus the shot by turning the focusing ring.

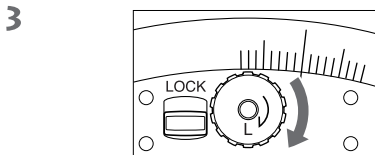

Turn the tilt lock knob in the direction of the arrow to lock the amount of tilt for the shot.

 When you tilt the lens, sharp portions of the tilt mechanism are exposed and care should be taken to avoid touching these portions.

4. Shift Function

Shifting moves the optical axis of the lens in parallel off the center of the imaging plane. Shift can be used to good effect in the situations shown below.

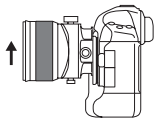

- If you photograph a subject such as a building with a normal lens, the top of the building tapers away. But by placing the camera parallel to the building and shifting the lens, you can correct this tapering effect.



- When you are shooting a reflective subject, you can move the camera to a position where the camera does not appear in the shot and then use shift to take the picture. This lets you keep the camera out of the shot without having to change the shot composition.

Using Shift

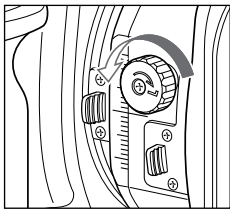

- 1 Loosen the shift lock knob by turning it in the direction of the arrow.

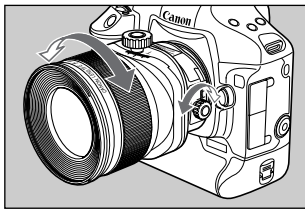

- 2 Turn the shift knob to adjust the amount of shift. Focus the shot by turning the focusing ring.

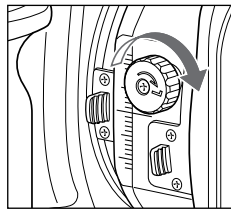

- 3 Turn the shift lock knob in the direction of the arrow to lock the amount of shift for the shot.

 When you shift the lens, sharp portions of the shift mechanism are exposed and care should be taken to avoid touching these portions. For EOS cameras with built-in flash, there may be contact with the lens while you operate the shift function.

- 
- With large amounts of shift, the amounts of peripheral light at the top and bottom or left and right sides of the screen may differ, so shooting with a small aperture is recommended.
 - The shift operation will be easier if the supplied cap is mounted on the shift knob (p.6).

5. Rotation

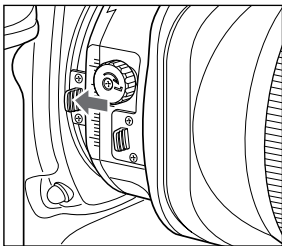

The rotation function enables you to change the direction of tilt or shift by rotating the tilt-shift mechanism. With the lens mounted on the camera, push the rotation lock release button towards the mount and then turn the tilt-shift mechanism.

- The rotation mechanism can be rotated through $\pm 90^\circ$. The lens clicks every 30° and locks in place in the 90° position.
- When rotating the lens, set the tilt and shift scales to the “0” position.
- Note that rotating the tilt-shift mechanism quickly while pressing on the rotation lock release button may cause the shift lock knob to strike your fingers.
- Do not operate the shift function while operating the rotation function. You may be injured by having your fingers caught.
- For EOS cameras with built-in flash, there may be contact with the lens while you operate the rotation function.

 In order to prevent shifts in position while shooting, shooting while rotation is locked, or shooting per click position is recommended.

Changing the Operation Direction of Tilt and Shift (TS rotation Function)

By using the TS rotation function, the relationship of the tilt and shift's operation direction can switch from right angle to parallel.

Press the TS rotation lock release button in the mounting direction while the lens is mounted on the camera, and then turn the tilt component.

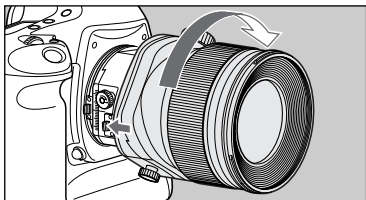

- There are clicks at the 45° position, and will be fixed in either the right angle or parallel position.

ⓘ When the tilt and shift are used in a parallel direction, vignetting will occur in the areas marked in gray in the following table.

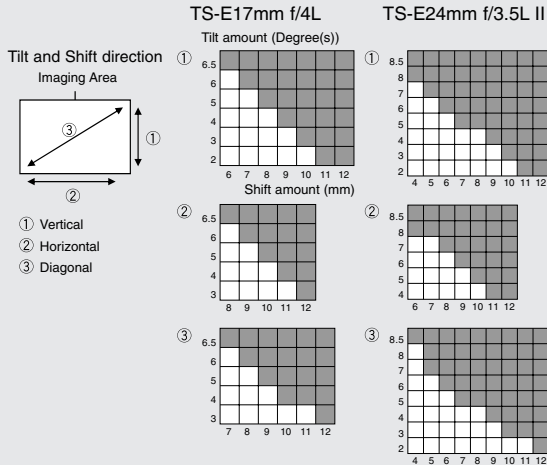

ⓘ In order to prevent shifts in position while shooting, shooting while TS rotation is locked, or shooting per click position is recommended.

6. Depth-of-Field Scale

(TS-E24mm f/3.5L II)

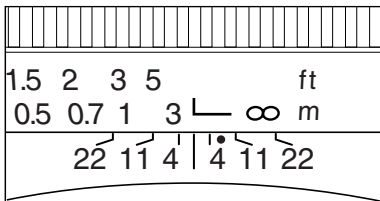

The depth of field is the distance in front of and behind the plane of focus on the subject that appears sharp. The depth of field is indicated by the area between the depth-of-field scale lines below the distance scale.



- The depth-of-field scale is only valid when the tilt scale is set to the “0” position.
- The depth-of-field scale is an approximate indicator.

7. Infrared Index

(TS-E24mm f/3.5L II)

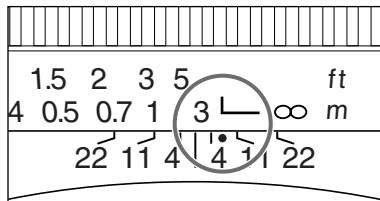

The infrared index corrects the focus setting when using monochrome infrared film. Focus on the subject in MF, then adjust the distance setting by moving the focusing ring to the corresponding infrared index mark.



Some EOS cameras cannot use infrared film. See the instructions for your EOS camera.



- The infrared index position is based on a wavelength of 800 nm.
- Be sure to observe the manufacturer's instructions when using infrared film.
- Use a red filter also when you take the picture.

8. TS-E Tripod Adapter (Sold Separately)

With some camera models, the tilt, shift and rotation functions cannot be used when the camera is mounted directly on a tripod. When this happens, fit the optional TS-E tripod adapter into the tripod mount socket on the camera before mounting the camera on the tripod.

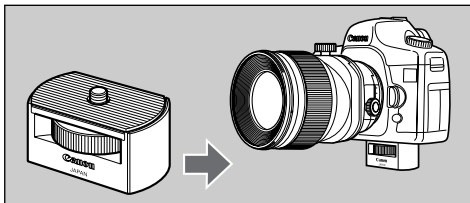

9. Exposure

Shots can be taken using AE (automatic exposure) as long as the tilt and shift scales are set to the “0” position.

The use of AE is not recommended when the lens is tilted or shifted as exposure errors may result. It is recommended that you use the exposure values when the tilt and shift scales are set to the “0” position as a guide and then take the shot with as many exposure settings as possible.

10. Hood (TS-E24mm f/3.5L II)

The EW-88B lens hood can keep unwanted light out of the lens, and also protects the lens from rain, snow, and dust.

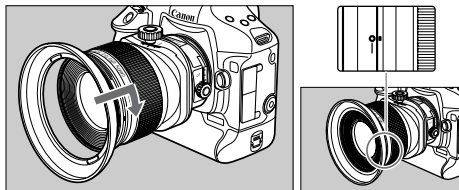

To attach the hood, align the hood's attachment position mark with the red dot on the front of the lens, then turn the hood as shown by the arrow until the lens' red dot is aligned with the hood's stop position mark. The hood can be reverse-mounted on the lens for storage.

 When attaching or detaching the hood, grasp the base of the hood to turn it. To prevent deformation, do not grasp the rim of the hood to turn it.

-  ● Cutting off harmful rays entering the lens by using both a hood as well as a piece of cardboard is recommended.
- A hood is not available for TS-E17mm f/4L.

11. Filters (Sold Separately) (TS-E24mm f/3.5L II)

You can attach filters to the filter mounting thread on the front of the lens.

- Only one filter may be attached.
- Use a polarizing Canon filter (82mm).

 A filter cannot be used with TS-E17mm f/4L.

12. Infinity Compensation Mark (TS-E24mm f/3.5L II)

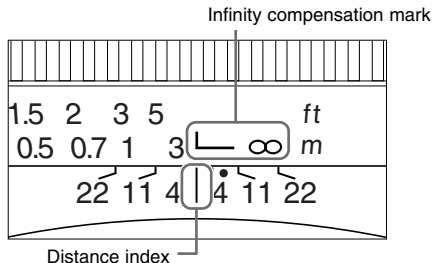

To compensate for shifting of the infinity focus point that results from changes in temperature. The infinity position at normal temperature is the point at which the vertical line of the L mark is aligned with the distance indicator on the distance scale.

- For accurate focusing of subjects at infinity, look through the viewfinder's magnified image* or the LCD screen's magnified image* while rotating the focusing ring.

* For cameras with Live View shooting capability.

13. Extension Tubes

(Sold Separately)

For TS-E24mm f/3.5L II, you can attach extension tube EF12 II for magnified shots. The shooting distance and magnification are shown below.

	Focusing Distance Range (mm)		Magnification (×)	
	Close distance	Long distance	Close distance	Long distance
EF12 II	182	198	0.85	0.51

- The extension tubes EF12 II and EF25 II cannot be used with TS-E17mm f/4L.
- Although extension tube EF25 II can be attached on TS-E24mm f/3.5L II, it is not recommended because the lens-to-subject distance will be very short.

Specifications

		TS-E17mm f/4L	TS-E24mm f/3.5L II
Focal Length/Aperture		17mm f/4	24mm f/3.5
Lens Construction		12 groups, 18 elements	11 groups, 16 elements
Minimum Aperture		f/22	f/22
Angle of View (Normal)	Diagonal	104°	84°
	Vertical	70° 30'	53°
	Horizontal	93°	74°
Min. Focusing Distance		0.25m (0.82ft.)	0.21m (0.69ft.)
Max. Magnification		0.14×	0.34×
Field of View		168 × 251mm (6.6 × 9.9inch)	72 × 107mm (2.8 × 4.2inch)
Tilt amount		±6.5°	±8.5°
Shift amount		±12mm	
Tilt scale display		1° increments	
Shift scale display		1mm increments	
Rotation mechanism		Locks at -90°, 0° and +90°, clicks every 30°	
TS Rotation mechanism		Locks at right angle and parallel, and clicks at 45°	

Specifications

	TS-E17mm f/4L	TS-E24mm f/3.5L II
Filter Diameter	—	82mm
Max. Diameter and Length	88.9 × 106.7mm (3.5 × 4.2inch)	88.5 × 106.9mm (3.5 × 4.2inch)
Weight	820g (28.9oz)	780g (27.5oz)
Hood	—	EW-88B
Lens Cap	Lens Cap 17	E-82
Case	LP1219	LP1319

- The lens length is measured from the mount surface to the front end of the lens. Add 26mm to the displayed length for TS-E17mm f/4L, and add 21.5mm to the displayed length for TS-E24mm f/3.5L II when including the lens cap and dust cap.
- The size and weight listed are for the lens only, except as indicated.
- The EF1.4 × II/EF2 × II extenders, 250D/500D close-up lenses and the gelatin filter holders III/IV cannot be used.
- Aperture settings are specified on the camera.
- All data listed is measured according to Canon standards.
- Product specifications and appearance are subject to change without notice.

Canon